

CBP1-80 Pluggable Terminal Blocks

Pitch : 5mm

Poles : 2P~16P

Electrical Rating	10A 300VAC
Housing Material	Polyamide 66, Green
Contact	Phosphor Bronze, 0.4t, Nickel Plated
Cage clamp	Brass, 0.7t, Nickel Plated
Screw	M2.6, Steel, Zine Plated
Solder Pin	Brass, Tin Plated
Working Temperature	-40°C to +105°C
Insulation withstand Voltage	AC2000V/min
Insulation resitance	500MΩ or more at DC 500V
Wire Range	24~14 AWG
Screw Torque Value	5Kg/cm

Unit : mm

CBP1-80K

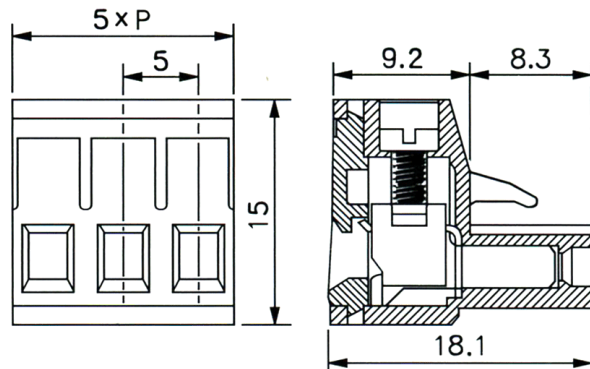
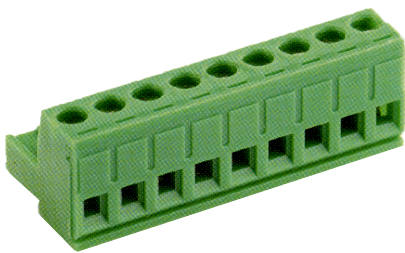

CBP1-80R

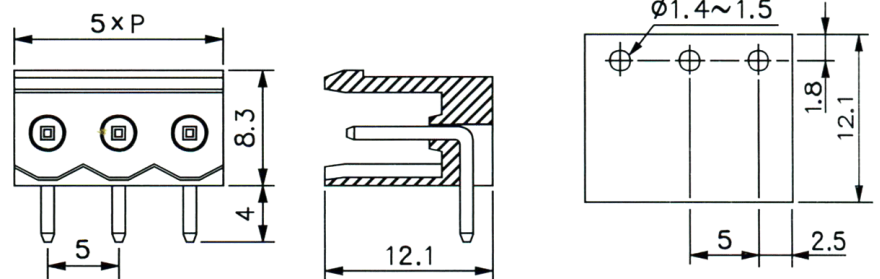

PCB LAYOUT

CBP1-80V

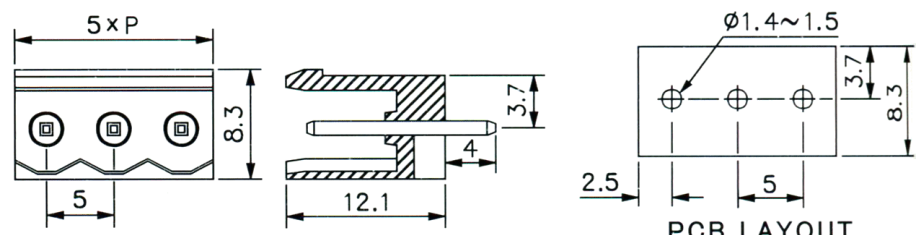
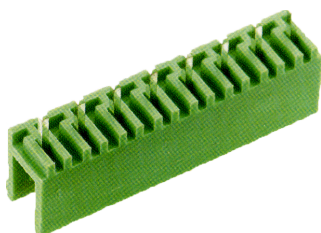

PCB LAYOUT

Unit : mm

CBP1-80R1

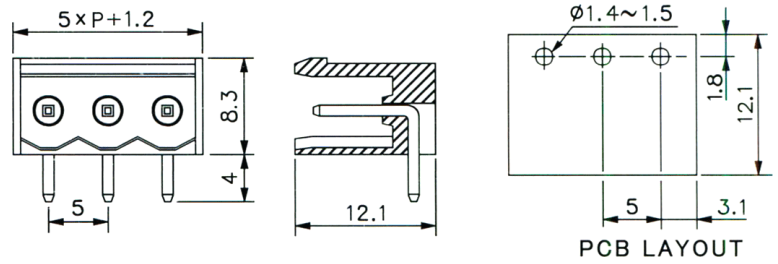
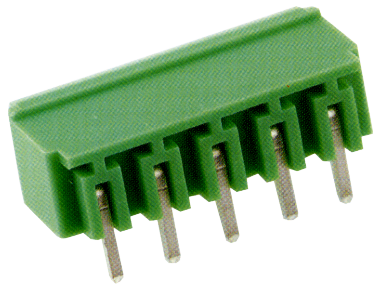

CBP1-80V1

Unit : mm

