

CBP70 Series Barrier Strip Terminal Blocks

Pitch : 7.62mm

Poles : 2P~32P

Cover Available

Electrical Rating	10A 300VAC
Housing Material	PA66, Black
Terminal	Brass, 0.8t Tin Plated
Screw	Steel, M3, Nickel Plated
Working Temperature	-40°C to +105°C
Insulation withstand Voltage	AC2000V at 1 min
Insulation resistance	500MΩ or more at DC 500V
Wire Range	22~12 AWG
Max. Torque Value	10Kg/cm

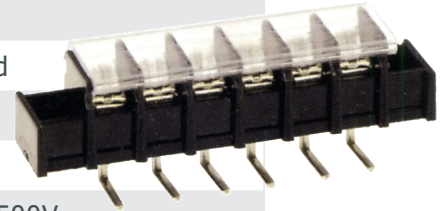

Unit : mm

CBP70-01

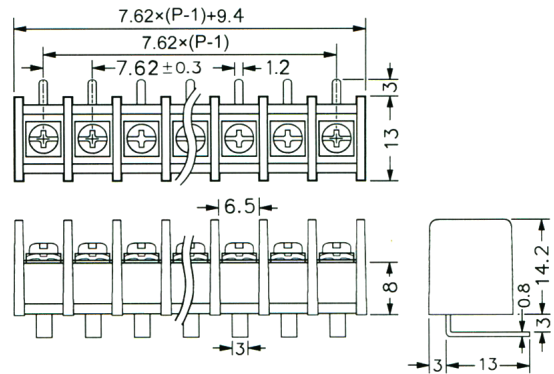
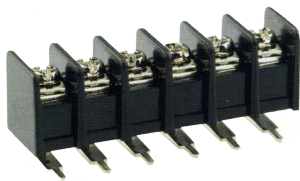

CBP70-02

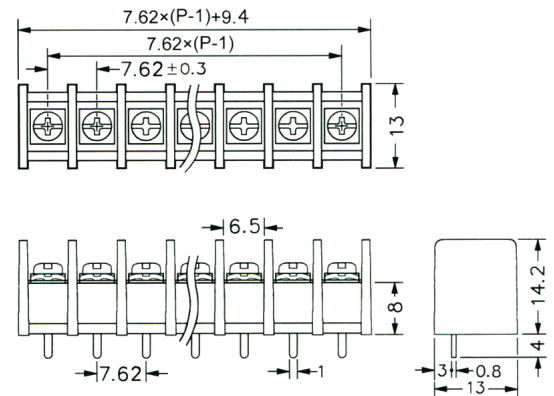
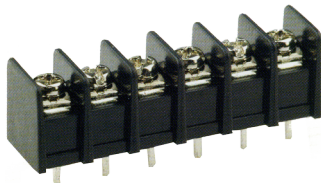

CBP70-03

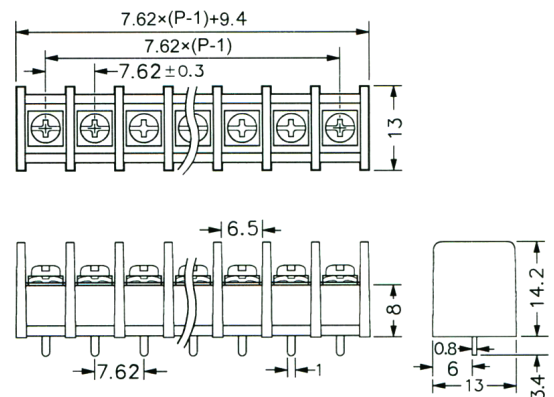
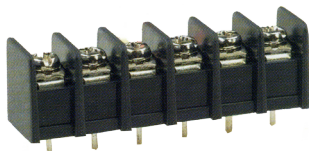

Unit : mm

CBP70-04A

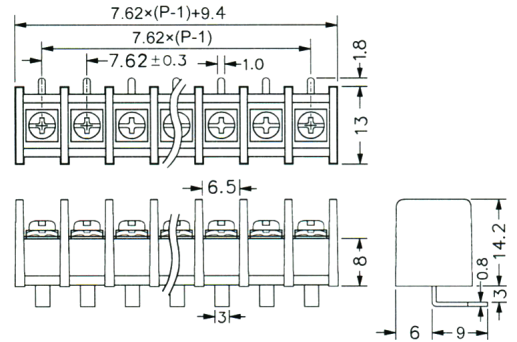
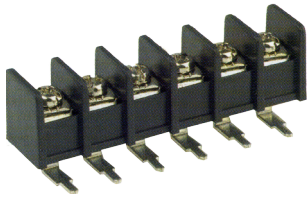

CBP70-04B

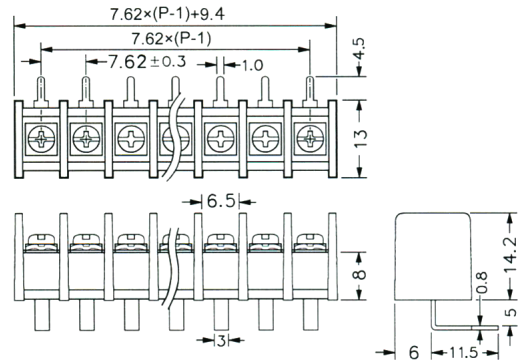
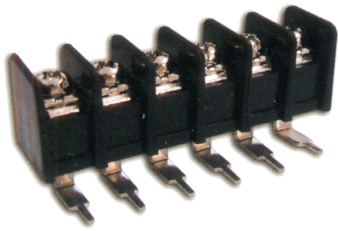

Unit : mm

CBP70-05

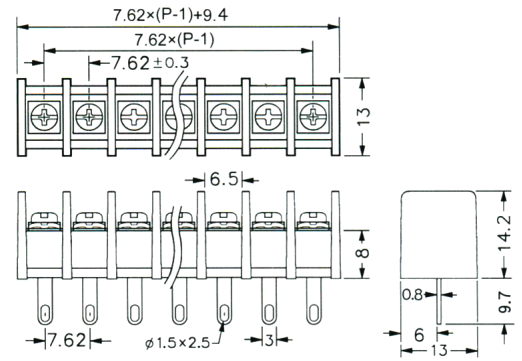
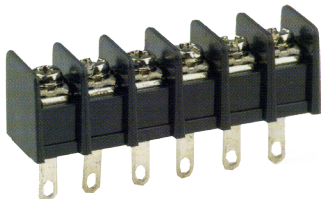

CBP70-06

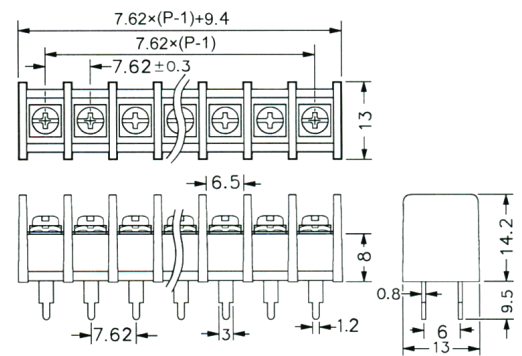
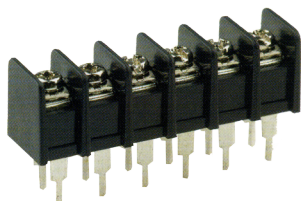

Unit : mm

CBP70-07

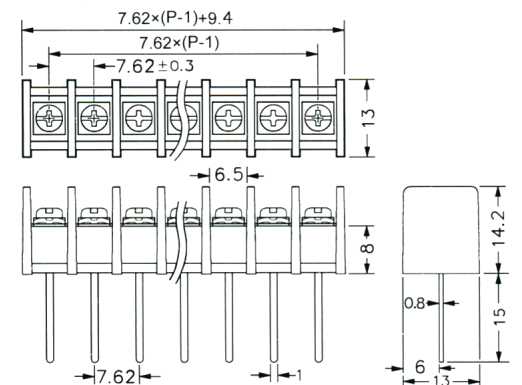
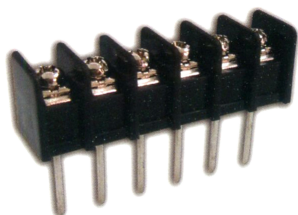

Unit : mm